

# Raccordi super-rapidi Serie X6000 in Acciaio Inox 316L

Novità

Diametri esterni tubo: 4, 6, 8, 10, 12 mm  
 Filetti dei raccordi: cilindrici (G1/8, G1/4, G3/8, G1/2),  
 conici (R1/8, R1/4, R3/8, R1/2)

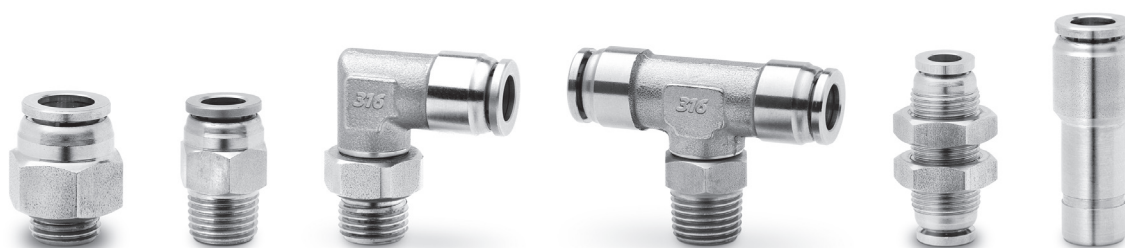

La gamma dei raccordi Serie X6000 in Acciaio Inox 316L permette di realizzare connessioni per fluidi e ambienti aggressivi.

La pinza assicura un'eccellente presa tra il raccordo e il tubo.

I raccordi Serie X6000 sono ideati per applicazioni nei settori della Pneumatica, Fluidi, Chimica, Medicale, Industria Alimentare e dell'Imballaggio.

4

COLLEGAMENTO

## CARATTERISTICHE GENERALI

<b>Materiali</b>	1 = Corpo	Acciaio INOX 316L
	2 = Guarnizioni	FKM Alimentare
	3 = Anello di Sostegno	Acciaio INOX 316L
	4 = Pinza di aggraffaggio	Acciaio INOX 301
	5 = Bussola di Fermo	Acciaio INOX 316L
	6 = Bussola di sgancio	Acciaio INOX 316L
<b>Filettature</b>	GAS conico ISO 7 (BSPT) GAS cilindrico ISO 228 (BSP)	
<b>Pressione</b>	max 18 bar (vedere tubi)	
<b>Tubo di collegamento</b>	Poliammide 6-12, Rilsan PA11, Polietilene, PU, Poliestere Hytrel	
<b>Diametri</b>	4 - 6 - 8 - 10 - 12 mm	
<b>Fluido</b>	aria compressa e acqua potabile (per altri liquidi consultare i nostri tecnici)	
<b>Temperatura</b>	-15°C + 100°C (vedere caratteristiche dei tubi impiegati)	

## Raccordo con tubo di collegamento

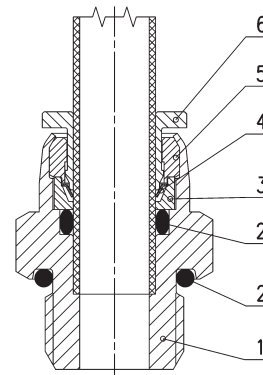

## Raccordi Mod. X6510

Novità

Diritto Maschio Conico

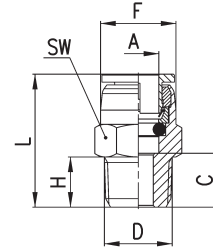

## DIMENSIONI

Mod.	A	C	D	F	H	L	SW	Peso (g)	Confezione
X6510 4-1/8	4	8	R1/8	9,9	8	20,5	10	9	10
X6510 4-1/4	4	8	R1/4	9,9	8	18,4	14	15	10
X6510 6-1/8	6	7,5	R1/8	11,9	8	21	12	10	10
X6510 6-1/4	6	9	R1/4	11,9	10	22,5	14	17	10
X6510 8-1/8	8	8	R1/8	15	8	24	15	16	10
X6510 8-1/4	8	10	R1/4	15	10	26	15	20	10
X6510 10-1/4	10	11	R1/4	17,4	10	28	19	28	10
X6510 10-3/8	10	12	R3/8	17,4	11	29	19	35	10
X6510 10-1/2	10	14	R1/2	17,4	13	31	22	55	10
X6510 12-1/4	12	12,5	R1/4	20	10	31,5	22	42	10
X6510 12-3/8	12	12,5	R3/8	20	11	31,5	22	44	10
X6510 12-1/2	12	13,5	R1/2	20	13	32,5	22	59	10

## Raccordi Mod. X6512

Novità

Diritto Maschio Cilindrico

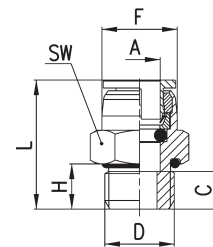

## DIMENSIONI

Mod.	A	C	D	F	H	L	SW	Peso (g)	Confezione
X6512 4-1/8	4	5,5	G1/8	9,9	5,7	18	14	11	10
X6512 4-1/4	4	5,7	G1/4	9,9	5,7	18,1	14	18	10
X6512 6-1/8	6	5,5	G1/8	11,9	5,7	19	14	12	10
X6512 6-1/4	6	5,5	G1/4	11,9	6	20	17	19	10
X6512 8-1/8	8	6,5	G1/8	15	5,7	24,5	15	18	10
X6512 8-1/4	8	6	G1/4	15	6	22	17	21	10
X6512 10-1/4	10	8,3	G1/4	17,4	6	25,3	19	28	10
X6512 10-3/8	10	6,3	G3/8	17,4	6,5	23,3	22	29	10
X6512 10-1/2	10	10	G1/2	17,4	9,5	27	27	60	10
X6512 12-1/4	12	8,4	G1/4	20	6	27,4	22	40	10
X6512 12-3/8	12	9	G3/8	20	6,5	28	22	42	10
X6512 12-1/2	12	12,4	G1/2	20	9,5	31,4	27	71	10

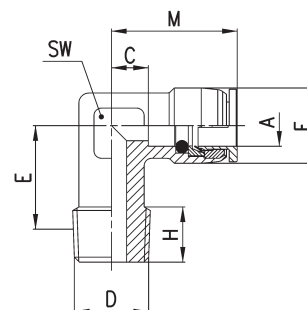
**Raccordi Mod. X6500**
**Novità**
**Gomito Conico Fisso**

DIMENSIONI										
Mod.	A	C	D	E	F	H	M	SW	Peso (g)	Confezione
X6500 4-1/8	4	8	R1/8	10,5	11	8	20,5	12	22	10
X6500 6-1/8	6	9	R1/8	10,5	11,9	8	22,5	12	20	10
X6500 6-1/4	6	10	R1/4	14,7	11,9	10	23,5	12	24	10
X6500 8-1/8	8	8	R1/8	13	15	8	24	12	26	10
X6500 8-1/4	8	8	R1/4	14,6	15	10	24	12	25	10
X6500 10-1/4	10	8,5	R1/4	14	17,4	10	25,5	14	36	10
X6500 10-3/8	10	8,5	R3/8	15	17,4	10,8	25,5	14	41	10
X6500 12-1/4	12	9,5	R1/4	15	20	10	28,5	17	49	10
X6500 12-3/8	12	9,5	R3/8	16,5	20	11	28,5	17	55	10

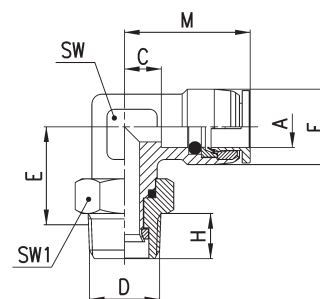
**Raccordi Mod. X6520**
**Novità**
**Gomito Conico Girevole**

DIMENSIONI											
Mod.	A	C	D	E	F	H	M	SW	SW1	Peso (g)	Confezione
X6520 4-1/8	4	4	R1/8	15,3	11	8	16,7	12	12	20	10
X6520 4-1/4	4	4	R1/4	16,8	11	10	16,7	12	14	24	10
X6520 6-1/8	6	8,8	R1/8	15,3	11,9	8	22,1	12	12	24	10
X6520 6-1/4	6	7,8	R1/4	19,8	11,9	10	19,4	14	15	33	10
X6520 8-1/8	8	9,4	R1/8	18,3	15	8	25,2	14	12	41	10
X6520 8-1/4	8	9,4	R1/4	19,8	15	10	25,2	14	15	44	10
X6520 10-1/4	10	10,6	R1/4	20,6	17,4	10	27,5	17	15	57	10
X6520 10-3/8	10	10,6	R3/8	20,4	17,4	11	27,5	17	19	65	10
X6520 12-1/4	12	14	R1/4	23,6	20	10	32,8	18	15	55	10
X6520 12-3/8	12	14	R3/8	24,6	20	11	32,8	18	19	65	10
X6520 12-1/2	12	15,6	R1/2	28,1	20	13	34,4	19	22	80	10

## Raccordi Mod. X6430

Novità

T Conico Centrale Girevole

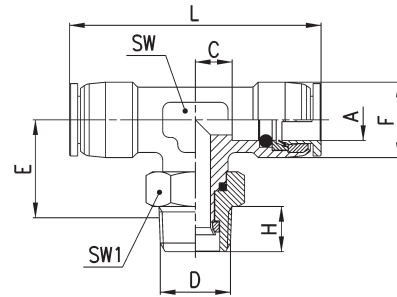

## DIMENSIONI

Mod.	A	C	D	E	F	H	L	SW	SW1	Peso (g)	Confezione
X6430 4-1/8	4	4	R1/8	15,3	11	8	33,4	12	12	33	10
X6430 4-1/4	4	4	R1/4	16,8	11	10	33,4	12	14	41	10
X6430 6-1/8	6	8,8	R1/8	15,3	11,9	8	44,2	12	12	33	10
X6430 6-1/4	6	7,8	R1/4	19,8	11,9	10	38,8	14	15	45	10
X6430 8-1/8	8	9,4	R1/8	18,3	15	8	50,4	14	12	46	10
X6430 8-1/4	8	9,4	R1/4	19,8	15	10	50,4	14	15	54	10
X6430 10-1/4	10	10,6	R1/4	20,6	17,4	10	55	17	15	77	10
X6430 10-3/8	10	10,6	R3/8	20,4	17,4	11	55	17	19	84	10
X6430 12-1/4	12	14	R1/4	23,6	20	10	65,6	18	15	79	10
X6430 12-3/8	12	14	R3/8	24,6	20	11	65,6	18	19	87	10
X6430 12-1/2	12	15,6	R1/2	28,1	20	13	68,8	19	22	100	10

## Raccordi Mod. X6522

Novità

Gomito Cilindrico Girevole

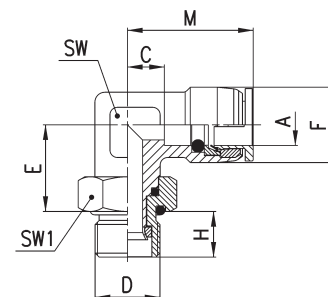

## DIMENSIONI

Mod.	A	C	D	E	F	H	M	SW	SW1	Peso (g)	Confezione
X6522 4-1/8	4	4	G1/8	15,3	11	6,5	16,7	12	14	22	10
X6522 4-1/4	4	4	G1/4	15,8	11	9	16,7	12	14	25	10
X6522 6-1/8	6	8,8	G1/8	15,3	11,9	6,5	22,1	12	14	26	10
X6522 6-1/4	6	7,8	G1/4	18,8	11,9	9	19,4	14	17	40	10
X6522 8-1/8	8	9,4	G1/8	18,3	15	6,5	25,2	14	14	43	10
X6522 8-1/4	8	9,4	G1/4	18,8	15	9	25,2	14	17	46	10
X6522 10-1/4	10	10,6	G1/4	19,6	17,4	9	27,5	17	17	59	10
X6522 10-3/8	10	10,6	G3/8	19,9	17,4	9	27,5	17	22	72	10
X6522 12-1/4	12	14	G1/4	22,6	20	9	32,8	18	17	63	10
X6522 12-3/8	12	14	G3/8	24,1	20	9	32,8	18	22	73	10
X6522 12-1/2	12	14	G1/2	26,6	20	9,5	32,8	18	27	83	10

**Raccordi Mod. X6432**
**Novità**

T Cilindrico Centrale Girevole

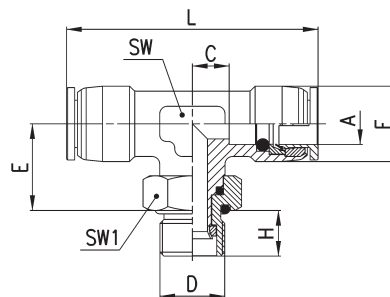
**DIMENSIONI**

Mod.	A	C	D	E	F	H	L	SW	SW1	Peso (g)	Confezione
<b>X6432 4-1/8</b>	4	4	G1/8	15,3	11	6,5	33,4	12	14	33	10
<b>X6432 4-1/4</b>	4	4	G1/4	15,8	11	9	33,4	12	14	46	10
<b>X6432 6-1/8</b>	6	8,8	G1/8	15,3	11,9	6,5	44,2	12	14	35	10
<b>X6432 6-1/4</b>	6	7,8	G1/4	18,8	11,9	9	38,8	14	17	47	10
<b>X6432 8-1/8</b>	8	9,4	G1/8	18,3	15	6,5	50,4	14	14	52	10
<b>X6432 8-1/4</b>	8	9,8	G1/4	18,8	15	9	50,4	14	17	57	10
<b>X6432 10-1/4</b>	10	10,6	G1/4	19,6	17,4	9	55	17	17	79	10
<b>X6432 10-3/8</b>	10	10,6	G3/8	19,9	17,4	9	55	17	22	91	10
<b>X6432 12-1/4</b>	12	14	G1/4	22,6	20	9	65,6	18	17	82	10
<b>X6432 12-3/8</b>	12	14	G3/8	24,1	20	9	65,6	18	22	94	10
<b>X6432 12-1/2</b>	12	14	G1/2	26,6	20	9,5	65,6	18	27	115	10

**Raccordi Mod. X6580**
**Novità**

Diritto Intermedio

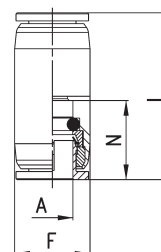

**DIMENSIONI**

Mod.	A	F	L	N	Peso (g)	Confezione
<b>X6580 4</b>	4	10	26	12,5	10	10
<b>X6580 6</b>	6	12	28	13,5	15	10
<b>X6580 8</b>	8	15	33	16	26	10
<b>X6580 10</b>	10	18	35,5	17	39	10
<b>X6580 12</b>	12	20	41	19	54	10

Raccordi Mod. X6550

Novità

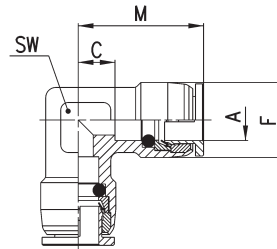
Gomito Intermedio



DIMENSIONI

Mod.	A	C	F	M	SW	Peso (g)	Confezione
X6550 4	4	8	11	20,5	12	24	10
X6550 6	6	9	11,9	22,5	12	23	10
X6550 8	8	8	15	24	12	28	10
X6550 10	10	8,5	17,4	25,5	14	42	10
X6550 12	12	9,5	20	28,5	17	58	10

Raccordi Mod. X6540

Novità

T Intermedio

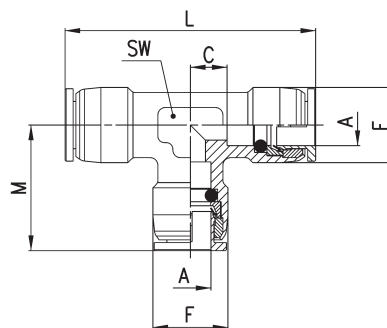

DIMENSIONI

Mod.	A	C	F	L	M	SW	Peso (g)	Confezione
X6540 4	4	8	11	41	20,5	12	32	10
X6540 6	6	8,5	11,9	44	22	12	33	10
X6540 8	8	9	15	50	25	14	44	10
X6540 10	10	8,5	17,4	51	25,5	17	54	10
X6540 12	12	9,5	20	57	28,5	17	80	10

Raccordi Mod. X6590

Novità

Diritto Intermedio Passaparete

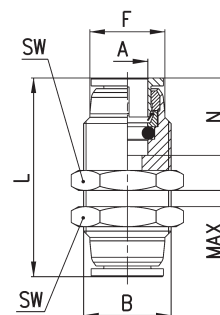

DIMENSIONI

Mod.	A	B	F	L	N	MAX	SW	Peso (g)	Confezione
X6590 4	4	M11X1	9,7	29	12,5	6	14	17	10
X6590 6	6	M13X1	11,6	32	13,5	8	16	29	10
X6590 8	8	M16X1	14,7	36,5	16	8	19	40	10
X6590 10	10	M19X1	17,4	42	17	11	22	62	10
X6590 12	12	M22X1	20	48	19	15	27	103	10

**Raccordi Mod. X6800**

Riduzione Tubo-Codolo

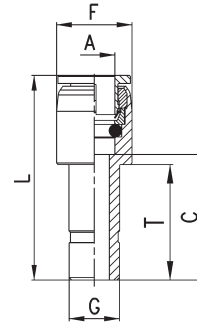
**Novità**

DIMENSIONI									
Mod.	A	C	F	G	L	T	Peso (g)	Confezione	
<b>X6800 4-6</b>	4	16,5	10	6	29	15,3	7	10	
<b>X6800 4-8</b>	4	19,5	10	8	32	17,8	10	10	
<b>X6800 6-8</b>	6	19,5	12	8	33	17,8	11	10	
<b>X6800 6-10</b>	6	22,5	12	10	36	20	12	10	
<b>X6800 6-12</b>	6	23	12	12	36,5	20	19	10	
<b>X6800 8-10</b>	8	22,5	15	10	38,5	23	14	10	
<b>X6800 8-12</b>	8	24,5	15	12	40,5	23	21	10	
<b>X6800 10-12</b>	10	26	18	12	45	23	27	10	