

Raccordi rapidi per tubi plastici Serie 1000

Diametri esterni tubo: \varnothing 5/3, 6/4, 8/6, 10/8, 12/10, 15/12,5
 Attacchi: M5, M6, M12 x1, M12 x1,25, G1/8, G1/4, G3/8, G1/2, R1/8, R1/4, R3/8, R1/2



I raccordi rapidi della Serie 1000, disponibili in 28 modelli, possono essere montati facilmente senza l'ausilio di chiave anche con tubi rigidi in PA. Per la chiusura manuale e con chiave è previsto comunque un dado di bloccaggio. La particolare forma del cono di conduzione evita possibili tagli del tubo.

CARATTERISTICHE GENERALI

Materiale	corpo e dado: OT nichelato; O-ring: NBR; guarnizioni filetto: PTFE - PA, AL
Filettature	GAS conico ISO 7 (BSPT) GAS cilindrico ISO 228 (BSP) M5- M6 NPT e metrico su richiesta
Pressione	la pressione nominale dei raccordi è sempre superiore alla pressione di utilizzo del tubo
Tubo di collegamento	PA polietilene PVC intrecciato rilsan PU
Diametri	da 5/3 mm + 15/12,5 mm
Fluido	aria compressa e fluidi a bassa pressione
Temperatura	(vedere caratteristiche dei tubi impiegati)

Raccordo con tubo di conduzione

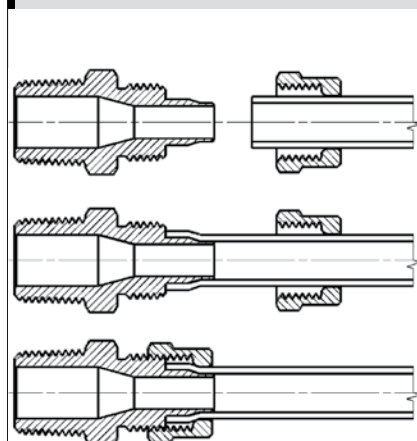

Raccordi Mod. 1510

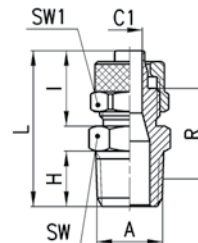

INGOMBRI										
Mod.	Tubo	A	C1	H	I	L	R	SW	SW1	Peso (g)
1510 5/3-1/8	5/3	R1/8	2	7,5	12,5	24,5	14,5	12	8	10
1510 6/4-1/8	6/4	R1/8	3	7,5	15	27	16	12	12	15
1510 6/4-1/4	6/4	R1/4	3	11	15	31	18,5	14	12	19
1510 6/4-3/8	6/4	R3/8	3	11,5	15	31,5	18,5	17	12	22
1510 6/4-1/2	6/4	R1/2	3	14	15	34,5	20	22	12	38
1510 6/4-M12x1,25	6/4	M12X1,25	3	10	15	30	18	13	12	17
1510 8/6-1/8	8/6	R1/8	5	7,5	15	27	16	13	14	19
1510 8/6-1/4	8/6	R1/4	5	11	15	31	18,5	14	14	20
1510 8/6-3/8	8/6	R3/8	5	11,5	15	31,5	18,5	17	14	25
1510 8/6-1/2	8/6	R1/2	5	14	15	34,5	20	22	14	39
1510 10/8-1/8	10/8	R1/8	6,5	7,5	16,5	28,5	16,5	14	16	24
1510 10/8-1/4	10/8	R1/4	6,5	11	16,5	32,5	19	14	16	24
1510 10/8-3/8	10/8	R3/8	6,5	11,5	16,5	33	19	17	16	27
1510 10/8-1/2	10/8	R1/2	6,5	14	16,5	36	20,5	22	16	42
1510 12/10-3/8	12/10	R3/8	8,5	11,5	18	34,5	19	17	19	35
1510 12/10-1/2	12/10	R1/2	8,5	14	18	37,5	20,5	22	19	49
1510 15/12,5-1/2	15/12,5	R1/2	11	14	20	39,5	21	22	22	55

Raccordi Mod. 1511

Sprint®

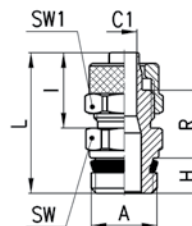

INGOMBRI										
Mod.	Tubo	A	C1	H	I	L	R	SW	SW1	Peso (g)
1511 5/3-M5	5/3	M5	2	4	12,5	21	10,5	8	8	5 *
1511 5/3-M6	5/3	M6	2	4	12,5	21	10,5	9	8	5 *
1511 5/3-1/8	5/3	G1/8	2	5,5	12,5	23,8	11,8	12	8	10
1511 6/4-M5	6/4	M5	3	4	13,5	22	10,5	8	9	6 *
1511 6/4-M6	6/4	M6	3	4	13,5	22	10,5	9	9	7 *
1511 6/4-1/8	6/4	G1/8	3	5,5	15	26,3	13,3	12	12	15
1511 6/4-1/4	6/4	G1/4	3	7	15	28	13,5	14	12	16
1511 6/4-3/8	6/4	G3/8	3	8	15	29,3	13,8	19	12	27
1511 8/6-1/8	8/6	G1/8	5	5,5	15	26,3	13,3	12	14	17
1511 8/6-1/4	8/6	G1/4	5	7	15	28	13,5	14	14	18
1511 8/6-3/8	8/6	G3/8	5	8	15	29,3	13,8	19	14	27
1511 10/8-1/8	10/8	G1/8	6,5	5,5	16,5	27,8	13,8	14	16	23
1511 10/8-1/4	10/8	G1/4	6,5	7	16,5	29,5	14	14	16	25
1511 10/8-3/8	10/8	G3/8	6,5	8	16,5	30,8	14,3	19	16	30
1511 10/8-1/2	10/8	G1/2	6,5	9	16,5	32,5	15	22	16	36
1511 12/10-3/8	12/10	G3/8	8,5	8	18	32,3	14,3	19	19	39
1511 12/10-1/2	12/10	G1/2	8,5	9	18	34	15	22	19	42
1511 15/12,5-1/2	15/12,5	G1/2	11	9	20	36	15,5	22	22	52

* = con O-Ring montato

Raccordi Mod. 1560
Sprint®

Modello Sprint girevole

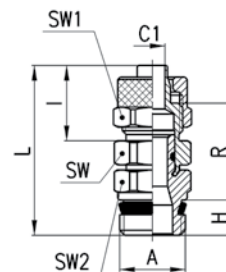

INGOMBRI											
Mod.	Tubo	A	C1	H	I	L	R	SW	SW1	SW2	Peso (g)
1560 6/4-1/8	6/4	G1/8	3	5,5	15	31	18	12	12	12	19
1560 6/4-1/4	6/4	G1/4	3	7	15	32,5	18	12	12	14	25
1560 8/6-1/8	8/6	G1/8	5	5,5	15	32	19	13	14	12	21
1560 8/6-1/4	8/6	G1/4	5	7	15	33,5	19	13	14	14	26
1560 10/8-1/4	10/8	G1/4	6,5	7	16,5	34,5	19	14	16	14	27
1560 10/8-3/8	10/8	G3/8	6,5	8	16,5	36	19,5	14	16	19	38
1560 12/10-3/8	12/10	G3/8	6,5	8	18	38	20	17	19	19	46

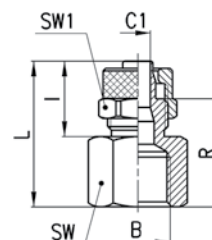
Raccordi Mod. 1463

INGOMBRI										
Mod.	Tubo	B	C1	I	L	R	SW	SW1	SW2	Peso (g)
1463 5/3-1/8	5/3	G1/8	2	12,5	22,5	16	13	8		10
1463 6/4-1/8	6/4	G1/8	3	15	25	17,5	13	12		14
1463 6/4-1/4	6/4	G1/4	3	15	26,5	19	17	12		21
1463 6/4-3/8	6/4	G3/8	3	15	27,5	20	20	12		25
1463 8/6-1/8	8/6	G1/8	5	15	25	17,5	13	14		16
1463 8/6-1/4	8/6	G1/4	5	15	26,5	19	17	14		22
1463 8/6-3/8	8/6	G3/8	5	15	27,5	20	20	14		26
1463 10/8-1/8	10/8	G1/8	6,5	16,5	21,5	13	14	16		19
1463 10/8-1/4	10/8	G1/4	6,5	16,5	28	19,5	17	16		28
1463 10/8-3/8	10/8	G3/8	6,5	16,5	29	20,5	20	16		31
1463 10/8-1/2	10/8	G1/2	6,5	16,5	33	24,5	24	16		43
1463 12/10-3/8	12/10	G3/8	8,5	18	30,5	20,5	20	19		37

Raccordi Mod. 1541

Sprint®

Modello Sprint girevole

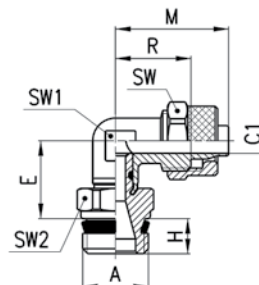

INGOMBRI											
Mod.	Tubo	A	C1	E	H	M	R	SW	SW1	SW2	Peso (g)
1541 6/4-1/8	6/4	G1/8	3	15	5,5	22,5	15	12	10	12	22
1541 6/4-1/4	6/4	G1/4	3	15	7	22,5	15	12	10	14	27
1541 8/6-1/8	8/6	G1/8	5	15	5,5	22,5	15	14	10	12	23
1541 8/6-1/4	8/6	G1/4	5	15	7	22,5	15	14	10	14	28
1541 10/8-1/4	10/8	G1/4	6,5	16	7	25,5	17	16	12	14	35

Raccordi Mod. 1500

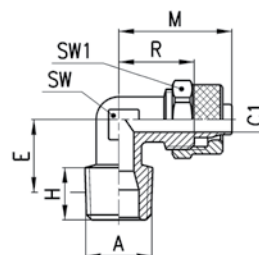

INGOMBRI											
Mod.	Tubo	A	C1	E	H	M	R	SW	SW1	Peso (g)	
1500 5/3-1/8	5/3	R1/8	2	13	7,5	21,5	15	8	8	11	
1500 6/4-1/8	6/4	R1/8	3	13	7,5	22,5	15	8	12	15	
1500 6/4-1/4	6/4	R1/4	3	15,5	11	22,5	15	10	12	21	
1500 6/4-3/8	6/4	R3/8	3	17	11,5	23,5	16	12	12	27	
1500 6/4-M12x1,25	6/4	M12x1,25	3	14	10	22,5	15	10	12	18	
1500 8/6-1/8	8/6	R1/8	5	13	7,5	22,5	15	10	14	19	
1500 8/6-1/4	8/6	R1/4	5	15,5	11	22,5	15	10	14	21	
1500 8/6-3/8	8/6	R3/8	5	17	11,5	24	16	12	14	29	
1500 8/6-1/2	8/6	R1/2	5	21,5	14	27	19	16	14	48	
1500 10/8-1/8	10/8	R1/8	6,5	15	7,5	25,5	17	12	16	29	
1500 10/8-1/4	10/8	R1/4	6,5	17	11	25,5	17	12	16	29	
1500 10/8-3/8	10/8	R3/8	6,5	16,5	11,5	25,5	17	12	16	33	
1500 10/8-1/2	10/8	R1/2	6,5	21	14	28,5	20	16	16	58	
1500 12/10-3/8	12/10	R3/8	8,5	19	11,5	30	20	14	19	44	
1500 12/10-1/2	12/10	R1/2	8,5	21	14	30,5	20,5	16	19	59	
1500 15/12,5-1/2	15/12,5	R1/2	11	21	14	34	22,5	16	22	67	

Raccordo Mod. 1501 5/3-M5

Con Mod. 2661 montato

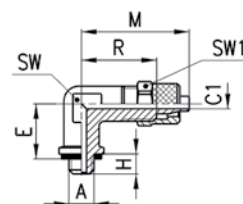
INGOMBRI

Mod.	Tubo	A	C1	E	H	M	R	SW	SW1	Peso (g)
1501 5/3-M5	5/3	M5	2	11	4	21,5	15	8	8	10

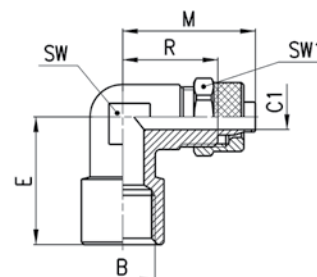
Raccordi Mod. 1493

INGOMBRI

Mod.	Tubo	B	C1	E	M	R	SW	SW1	Peso (g)
1493 6/4-1/8	6/4	G1/8	3	19	22,5	15	10	12	20
1493 6/4-1/4	6/4	G1/4	3	23,5	26	18,5	14	12	34
1493 8/6-1/8	8/6	G1/8	5	19	22,5	15	10	14	21
1493 8/6-1/4	8/6	G1/4	5	23,5	26	19	14	14	34
1493 10/8-1/4	10/8	G1/4	6,5	23,5	27,5	18	14	16	39
1493 12/10-3/8	12/10	G3/8	8,5	24,5	30,5	20,5	16	19	53

Raccordi Mod. 1431
Sprint®

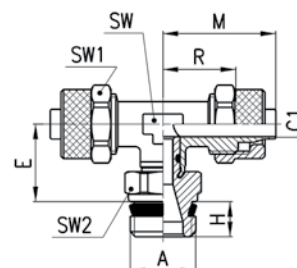
Modello Sprint girevole

INGOMBRI

Mod.	Tubo	A	C1	E	H	M	R	SW	SW1	SW2	Peso (g)
1431 6/4-1/8	6/4	G1/8	3	15	5,5	22,5	15	10	12	12	32
1431 6/4-1/4	6/4	G1/4	3	15	7	22,5	15	10	12	14	38
1431 8/6-1/8	8/6	G1/8	5	15	5,5	22,5	15	10	14	12	36
1431 8/6-1/4	8/6	G1/4	5	15	7	22,5	15	10	14	14	41
1431 10/8-1/4	10/8	G1/4	6,5	16	7	25,5	17	12	16	14	54

Raccordi Mod. 1410

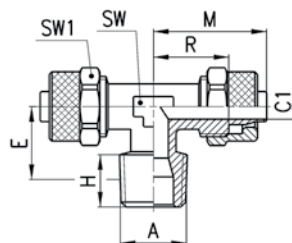

INGOMBRI										
Mod.	Tubo	A	C1	E	H	M	R	SW	SW1	Peso (g)
1410 5/3-1/8	5/3	R1/8	2	12,5	7,5	21,5	15	8	8	16
1410 6/4-1/8	6/4	R1/8	3	12,5	7,5	22,5	15	8	12	25
1410 6/4-1/4	6/4	R1/4	3	15,5	11	22,5	15	10	12	32
1410 8/6-1/8	8/6	R1/8	5	13	7,5	22,5	15	10	14	31
1410 8/6-1/4	8/6	R1/4	5	15,5	11	22,5	15	10	14	35
1410 10/8-1/8	10/8	R1/8	6,5	15	7,5	25,5	17	12	16	47
1410 10/8-1/4	10/8	R1/4	6,5	17	11	25,5	17	12	16	50
1410 10/8-1/2	10/8	R1/2	6,5	21,5	14	28,5	20	16	16	80
1410 12/10-3/8	12/10	R3/8	8,5	19	11,5	30	20	14	19	77
1410 12/10-1/2	12/10	R1/2	8,5	21,5	14	30,5	20,5	16	19	92
1410 15/12,5-1/2	15/12,5	R1/2	11	21,5	14	34	22,5	16	22	107

Raccordi Mod. 1420

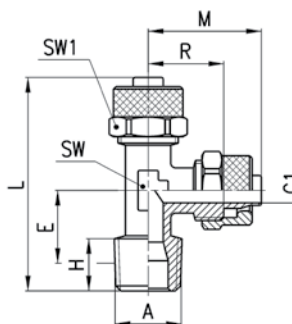

INGOMBRI											
Mod.	Tubo	A	C1	E	H	L	M	R	SW	SW1	Peso (g)
1420 5/3-1/8	5/3	R1/8	2	12,5	7,5	37,5	21,5	15	8	8	15
1420 6/4-1/8	6/4	R1/8	3	12,5	7,5	38,5	22,5	15	8	12	23
1420 6/4-1/4	6/4	R1/4	3	15,5	11	43	22,5	15	10	12	29
1420 8/6-1/8	8/6	R1/8	5	13	7,5	39	22,5	15	10	14	31
1420 8/6-1/4	8/6	R1/4	5	15,5	11	43	22,5	15	10	14	34
1420 10/8-1/8	10/8	R1/8	6,5	15	7,5	43,5	25,5	17	12	16	46
1420 10/8-1/4	10/8	R1/4	6,5	17	11	47	25,5	17	12	16	50

Raccordi Mod. 1521

Solo su richiesta

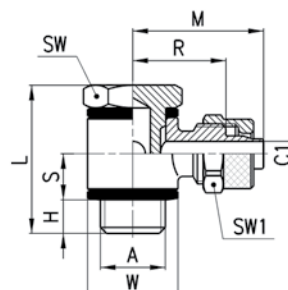

INGOMBRI												
Mod.	Tubo	A	C1	H	L	S	M	R	W	SW	SW1	Peso (g)
1521 5/3-M5	5/3	M5	2	3	18	4,5	17	10,5	Ø 9	8	8	10
1521 5/3-1/8	5/3	G1/8	2	6	27	8,5	22,5	16	Ø 14	14	8	26
1521 6/4-M5	6/4	M5	3	3	18	4,5	18	10,5	Ø 9	8	9	11
1521 6/4-1/8	6/4	G1/8	3	6	27	8,5	24	16,5	Ø 14	14	12	31
1521 6/4-1/4	6/4	G1/4	3	8	29,5	8,5	26	18,5	Ø 18	17	12	48
1521 6/4-3/8	6/4	G3/8	3	8	30	8,5	28	20,5	Ø 21	19	12	57
1521 8/6-1/8	8/6	G1/8	5	6	27	8,5	24	16,5	Ø 14	14	14	34
1521 8/6-1/4	8/6	G1/4	5	8	29,5	8,5	26	18,5	Ø 18	17	14	46
1521 8/6-3/8	8/6	G3/8	5	8	30	8,5	28	20,5	Ø 21	19	14	64

Raccordi Mod. 1525

Solo su richiesta

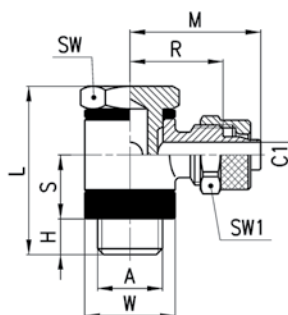

INGOMBRI												
Mod.	Tubo	A	C1	H	L	S	M	R	W	SW	SW1	Peso (g)
1525 6/4-1/8	6/4	G1/8	3	6	31	12,5	24	16,5	Ø14	14	12	35
1525 6/4-1/4	6/4	G1/4	3	8	33,5	12,5	26	18,5	Ø18	17	12	48
1525 6/4-3/8	6/4	G3/8	3	8	34	12,5	28	20,5	Ø21	19	12	60
1525 8/6-1/8	8/6	G1/8	5	6	31	12,5	24	16,5	Ø14	14	14	35
1525 8/6-1/4	8/6	G1/4	5	8	33,5	12,5	26	18,5	Ø18	17	14	54
1525 8/6-3/8	8/6	G3/8	5	8	34	12,5	28	20,5	Ø21	19	14	64
1525 10/8-1/8	10/8	G1/8	6,5	6	31	12,5	25	16,5	Ø14	14	16	38
1525 10/8-1/4	10/8	G1/4	6,5	8	33,5	12,5	27	18,5	Ø18	17	16	57
1525 10/8-3/8	10/8	G3/8	6,5	8	34	12,5	29,5	21	Ø21	19	16	69
1525 10/8-1/2	10/8	G1/2	6,5	9	35	12,5	32	23,5	Ø26	27	16	112
1525 12/10-3/8	12/10	G3/8	8	8	34	12,5	31,5	21,5	Ø21	19	19	77
1525 12/10-1/2	12/10	G1/2	8,5	9	35	12,5	33,5	23,5	Ø26	27	19	111
1525 15/12,5-1/2	15/12,5	G1/2	11	9	35	12,5	36,5	25	Ø26	27	22	120

Raccordi Mod. 1610

Assemblabili con Mod. 1631

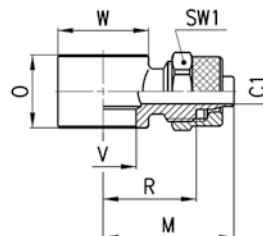

INGOMBRI									
Mod.	Tubo	C1	M	O	R	V	W	SW1	Peso (g)
1610 5/3-M5	5/3	2	17	9	10,5	5,1	Ø 9	8	8
1610 5/3-M6	5/3	2	17	9	10,5	5,1	Ø 9	8	•
1610 5/3-1/8	5/3	2	22,5	14,5	16	9,8	Ø 14	8	13
1610 6/4-M5	6/4	3	18	9	10,5	5,1	Ø 9	9	8
1610 6/4-M6	6/4	2	18	9	10,5	5,1	Ø 9	9	•
1610 6/4-1/8	6/4	3	24	14,5	16,5	9,8	Ø 14	12	18
1610 6/4-1/4	6/4	3	26	14,5	18,5	13,2	Ø 18	12	21
1610 6/4-3/8	6/4	3	28	14,5	20,5	16,7	Ø 21	12	22
1610 8/6-1/8	8/6	5	24	14,5	16,5	9,8	Ø 14	14	19
1610 8/6-1/4	8/6	5	26	14,5	18,5	13,2	Ø 18	14	22
1610 8/6-3/8	8/6	5	28	14,5	20,5	16,7	Ø 21	14	25
1610 10/8-1/8	10/8	6,5	25	14,5	16,5	9,8	Ø 14	16	25 *
1610 10/8-1/4	10/8	6,5	27	14,5	18,5	13,2	Ø 18	16	24 *
1610 10/8-3/8	10/8	6,5	29,5	14,5	21	16,7	Ø 21	16	28 *
1610 10/8-1/2	10/8	6,5	32	14,5	23,5	21	Ø 26	16	35 *
1610 12/10-3/8	12/10	8	31,5	14,5	21,5	16,7	Ø 21	19	36 *
1610 12/10-1/2	12/10	8,5	33,5	14,5	23,5	21	Ø 26	19	40 *
1610 15/12,5-1/2	15/12,5	11	36,5	14,5	25	21	Ø 26	22	48 *

* = assemblabili con Mod. 1635
 • = assemblabili con Mod. SCU, SVU, SCO... M5

Raccordi Mod. 1620

Assemblabili con Mod. 1631, 1635

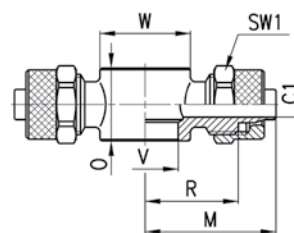

INGOMBRI									
Mod.	Tubo	C1	M	O	R	V	W	SW1	Peso (g)
1620 6/4-M5	6/4	3	18	9	10,5	5,1	Ø 9	9	12
1620 6/4-1/8	6/4	3	24	14,5	16,5	9,8	Ø 14	12	29
1620 6/4-1/4	6/4	3	26	14,5	18,5	13,2	Ø 18	12	31
1620 8/6-1/8	8/6	5	24	14,5	16,5	9,8	Ø 14	14	31
1620 8/6-1/4	8/6	5	26	14,5	18,5	13,2	Ø 18	14	34

Raccordi Mod. 1631 01

Assemblabili con i raccordi orientabili modello 6610; 6620; 1610; 1620; 2023; 1170

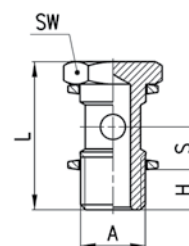

INGOMBRI

Mod.	A	H	L	S	SW	Peso (g)
1631 01-M5	M5	4	18	5,5	8	3 *
1631 01-1/8	G1/8	6	27	8,5	14	13
1631 01-1/4	G1/4	8	29,5	8,5	17	24
1631 01-3/8	G3/8	8	30	8,5	19	35
1631 01-1/2	G1/2	9	31	8,5	27	63

* = Acciaio zincato

Raccordi Mod. 1635 01

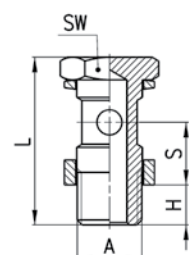
Assemblabili con i raccordi orientabili modello 6610; 6620; 1610; 1620; 2023; 1170



INGOMBRI

Mod.	A	H	L	S	SW	Peso (g)
1635 01-1/8	G1/8	6	31	12,5	14	15
1635 01-1/4	G1/4	8	33,5	12,5	17	27
1635 01-3/8	G3/8	8	34	12,5	19	37
1635 01-1/2	G1/2	9	35	12,5	27	71
1635 01-M12x1,25	M12x1,25	8	33,5	12,5	17	27 *
1635 01-M12x1,5	M12x1,5	8	33,5	12,5	17	27 *

* = modelli assemblabili con raccordi orientabili da 1/4

Raccordi Mod. 1631 02

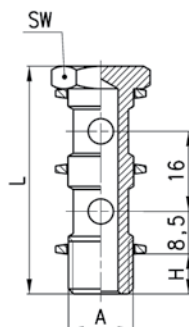
Assemblabili con i raccordi orientabili modello 6610; 6620; 1610; 1620; 2023; 1170

INGOMBRI

Mod.	A	H	L	SW	Peso (g)
1631 02-1/8	G1/8	6	43	14	18
1631 02-1/4	G1/4	8	45,5	17	33
1631 02-3/8	G3/8	8	46	19	48

Raccordi Mod. 1635 02

Assemblabili con i raccordi orientabili modello 6610; 6620; 1610; 1620; 2023; 1170

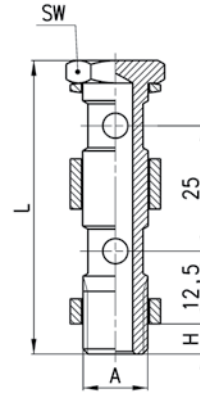

INGOMBRI					
Mod.	A	H	L	SW	Peso (g)
1635 02-1/8	G1/8	6	56	14	26
1635 02-1/4	G1/4	8	58,5	17	33
1635 02-3/8	G3/8	8	59	19	64
1635 02-1/2	G1/2	9	60	27	111

Raccordi Mod. 1631 03

Assemblabili con i raccordi orientabili modello 6610; 6620; 1610; 1620; 2023; 1170

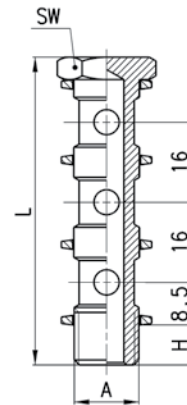

INGOMBRI					
Mod.	A	H	L	SW	Peso (g)
1631 03-1/8	G1/8	6	59	14	24
1631 03-1/4	G1/4	8	61,5	17	42
1631 03-3/8	G3/8	8	62	19	62

Raccordi Mod. 1580

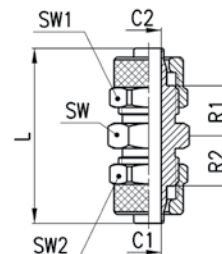

INGOMBRI										
Mod.	Tubo	C1	C2	L	R1	R2	SW	SW1	SW2	Peso (g)
1580 5/3	5/3	2	2	28,5	7,5	7,5	8	8	8	8
1580 6/4	6/4	3	3	34,5	10	10	12	12	12	22
1580 8/6	8/6	5	5	34,5	9,75	9,75	13	14	14	28
1580 10/8	10/8	6,5	6,5	38	10,5	10,5	14	16	16	38
1580 12/10	12/10	8,5	8,5	41	10,5	10,5	17	19	19	55
1580 15/12,5	15/12,5	11	11	45	11	11	22	22	22	80
1580 8/6-6/4	8/6-6/4	5	3	34,5	9,75	9,75	13	12	14	24
1580 10/8-6/4	10/8-6/4	6,5	3	36,5	10,5	10	14	12	16	31

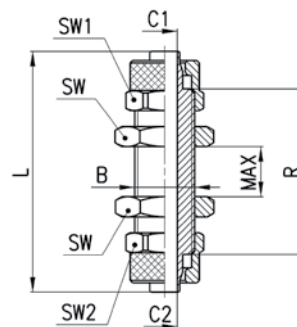
Raccordi Mod. 1590

INGOMBRI											
Mod.	Tubo	B	C1	C2	L	R	MAX	SW	SW1	SW2	Peso (g)
1590 5/3	5/3	M7x0,75	2	2	40	27	9	8	8	8	12
1590 6/4	6/4	M10x1	3	3	48	33	14	14	12	12	33
1590 8/6	8/6	M12x1	5	5	48	33	12	17	14	14	43
1590 10/8	10/8	M14x1	6,5	6,5	48	31	10	17	16	16	52
1590 12/10	12/10	M16x1	8,5	8,5	53	33	10	19	19	19	71
1590 6/4-5/3	6/4-5/3	M10x1	3	2	48	34	14	14	12	12	33
1590 8/6-6/4	8/6-6/4	M12x1	5	3	48	33	12	17	14	14	44

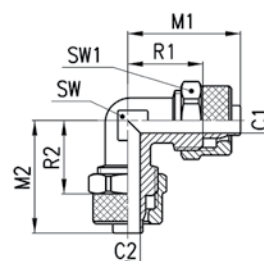
Raccordi Mod. 1550

INGOMBRI											
Mod.	Tubo	C1	C2	M1	M2	R1	R2	SW	SW1	Peso (g)	
1550 6/4	6/4	3	3	22,5	22,5	15	15	8	12	21	
1550 8/6	8/6	5	5	22,5	22,5	15	15	10	14	27	
1550 10/8	10/8	6,5	6,5	25,5	25,5	17	17	12	16	40	
1550 12/10	12/10	8,5	8,5	30	30	20	20	14	19	61	
1550 15/12,5	15/12,5	11	11	34	34	22,5	22,5	16	22	88	

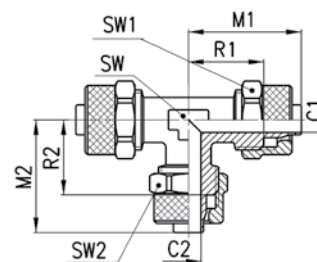
Raccordi Mod. 1540

INGOMBRI											
Mod.	Tubo	C1	C2	M1	M2	R1	R2	SW	SW1	SW2	Peso (g)
1540 5/3	5/3	2	2	21,5	21,5	15	15	8	8	8	17
1540 6/4	6/4	3	3	22,5	22,5	15	15	8	12	12	31
1540 8/6	8/6	5	5	22,5	22,5	15	15	10	14	14	39
1540 10/8	10/8	6,5	6,5	25,5	25,5	17	17	12	16	16	58
1540 12/10	12/10	8,5	8,5	30	30	20	20	14	19	19	90
1540 15/12,5	15/12,5	11	11	34	34	22,5	22,5	16	22	22	128
1540 8/6-6/4	8/6-6/4	5	3	22,5	22,5	15	15	10	14	12	38
1540 10/8-6/4	10/8-6/4	6,5	3	25,5	23,5	17	16,5	12	16	12	50
1540 10/8-8/6	10/8-8/6	6,5	5	25,5	24	17	16,5	12	16	14	53

Raccordi Mod. 1600

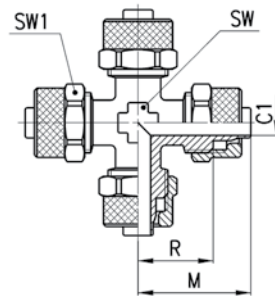

INGOMBRI

Mod.	Tubo	C1	M	R	SW	SW1	Peso (g)
1600 6/4	6/4	3	22,5	15	8	12	41
1600 8/6	8/6	5	22,5	15	10	14	52

Raccordi Mod. 1470

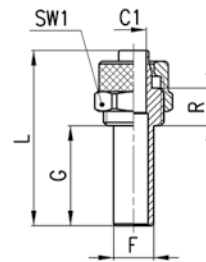

INGOMBRI

Mod.	Tubo	F	C1	G	L	R	SW1	Peso (g)
1470 6/4	6/4	6	3	20	35	7,5	12	11
1470 8/6	8/6	8	5	20	35	7,5	14	15

Anello di tenuta Mod. 2651

Nuova taglia



Materiale: Alluminio

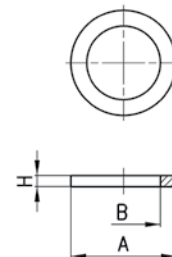

INGOMBRI

Mod.	A	B	H	Peso (g)
2651 1/8	14	9,8	1,5	1
2651 1/4	18	13,2	1,5	1
2651 3/8	22	16,7	1,5	1
2651 1/2	26	20,9	1,5	1
2651 1	38,5	33,4	1,5	2

Anello di tenuta Mod. 2661

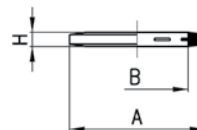

Materiale: Plastica



INGOMBRI				
Mod.	A	B	H	Peso (g)
2661 M3	4,9	2,8	0,7	1
2661 M5	8	5,2	1	1
2661 M6	9	6,2	1	1
2661 1/8	14	10,2	1,9	1
2661 1/4	18	13,5	1,9	1
2661 3/8	21	16,5	2,1	1
2661 1/2	26	21,2	1,9	1

Anello di tenuta Mod. 2665

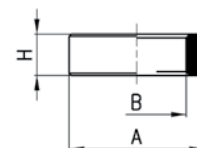

Materiale: Plastica

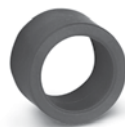

INGOMBRI				
Mod.	A	B	H	Peso (g)
2665 1/8	14	9,8	5	1
2665 1/4	18	13,2	5	1
2665 3/8	21	16,8	5	1
2665 1/2	26	21,1	5	1

Anello di tenuta Mod. 2669

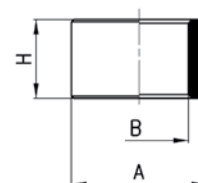
Materiale: Plastica



INGOMBRI				
Mod.	A	B	H	Peso (g)
2669 1/8	14	9,8	10	1
2669 1/4	18	13,2	10	2
2669 3/8	21	16,8	10	2
2669 1/2	26	21,1	10	2

Dado di bloccaggio Mod. 1703

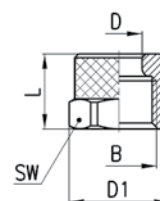

INGOMBRI							
Mod.	Tubo	B	D	D1	L	SW1	Peso (g)
1703 5/3-M7x0,75	5/3	M7x0,75	5,1	8,8	8,5	8	1
1703 6/4-M8x0,75	6/4	M8x0,75	6,1	9,8	8,5	9	2
1703 6/4-M10x1	6/4	M10x1	6,1	13,3	10	12	4
1703 8/6-M12x1	8/6	M12x1	8,2	15,5	10	14	5
1703 10/8-M14x1	10/8	M14x1	10,15	17,5	13	16	8
1703 12/10-M16x1	12/10	M16x1	12,2	21	13,5	19	12
1703 15/12,5-M20x1	15/12,5	M20x1	15,2	24,5	16	22	15

Dado di bloccaggio Mod. 1723

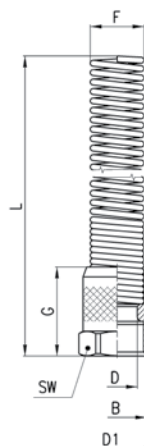

INGOMBRI									
Mod.	Tubo	B	F	D	D1	G	L	SW	Peso (g)
1723 6/4-M10x1	6/4	M10x1	8,9	6,1	13,3	18	90,5	12	15
1723 8/6-M12x1	8/6	M12x1	10,9	8,2	15,5	18	94,5	14	23
1723 10/8-M14x1	10/8	M14x1	12,5	10,15	17,5	22	96,5	16	29
1723 12/10-M16x1	12/10	M16x1	15,5	12,2	21	23,5	108	19	46
1723 15/12,5-M20x1	15/12,5	M20x1	18,5	15,2	24,5	28	120	22	57