

CONNETTORI PER ISOLE DI VALVOLE SERIE 3 PLUG-IN, 3 SERIALE (3F8), Y, H e CX2



Connettori dritti con cavo



Connettori 90° con cavo



Connettori collegamento mod. uscite digitali



Connettori collegamento mod. uscite digitali



Connett. M12 4 poli femm. (alim. elettr.)



Connett. M12 4 poli femm. 90° (alim. elettr.)



Connett. M12/M12B 5 poli femm. (Bus-In)



Connett. M12/M12B 5 poli femm. 90° (Bus-In)



Connett. M12/M12B 5 poli maschio (Bus-Out)



Connett. M12/M12B 5 poli masc. 90° (Bus-Out)



Connett. M12/M12B masc. con resist. termin.



Connett. M9 masc. con resist. termin. Cam.I.Net



Derivatore a T per Profibus-DP



Derivatore a T (CANopen e DeviceNet)



Connettore DUO M12 5 poli maschio dritto



Connettore DUO M12 5 poli maschio 90°



Cavo di programmazione per serie Y



Cavo di espansione per serie Y e H



Prolunga + connett. M8 3 poli maschio-femm.



Connett. collegam. elettr. serie Y Punto-Punto

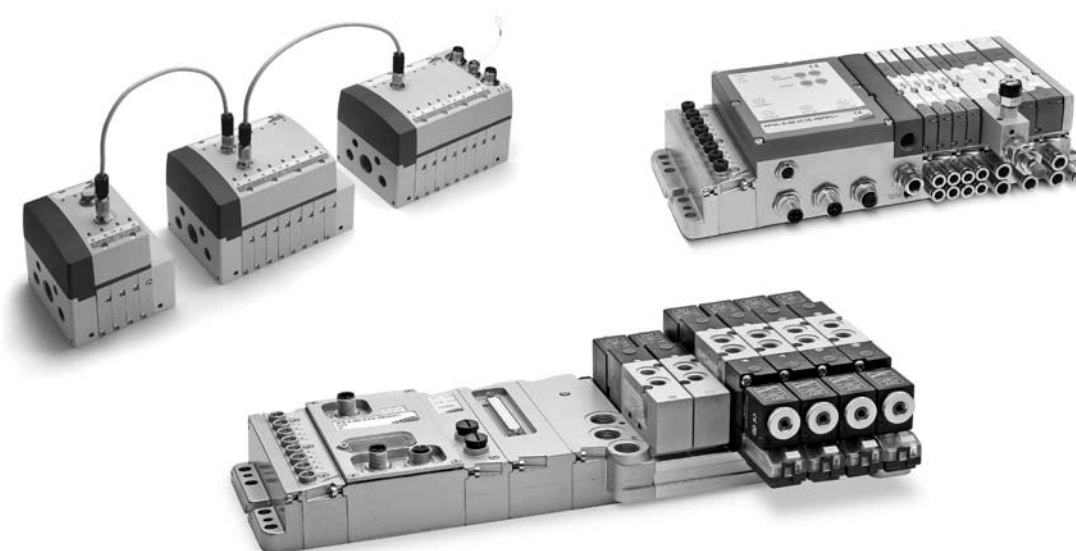

All'interno della sezione altri connettori.

Connettori dritti con cavo per 3 Plug-In e Y Multipolare

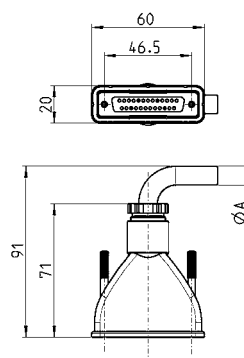
 Prese SUB-D 15 e 25 poli.
 Protezione: IP65.

Mod.	⊙A	N° poli	lunghezza cavo (m)	N° max posizioni valvola
G3X-3	8	15	3	6
G3X-5	8	15	5	6
G3X-10	8	15	10	6
G4X-3	10	25	3	11
G4X-5	10	25	5	11
G4X-10	10	25	10	11

Connettori angolari (90°) con cavo per 3 Plug-In e Y Multipolare

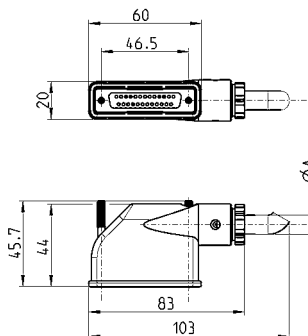
 Prese SUB-D 25 poli
 Protezione: IP65

Mod.	⊙A	N° poli	lunghezza cavo (m)	N° max posizioni valvola
G4X1-3	10	25	3	11
G4X1-5	10	25	5	11

Connettori per collegamento moduli uscite digitali ME-XXXX-DD *

 Prese SUB-D 37/25 poli
 Collegabili a: Serie Y multipolare e Serie 3 Plug-In
 Protezione: IP65

* Vedi pag.: 2/3.07.06 - 2/3.20.04

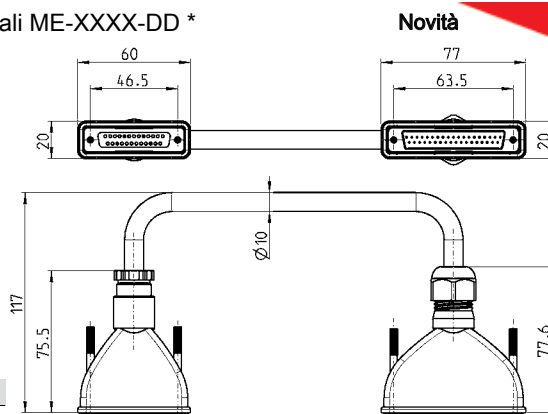

INGOMBRI

Mod.	N° poli connettore maschio	N° poli connettore femmina	lunghezza cavo (m)
G4X-G9W-3	37	25	3
G4X-G9W-5	37	25	5

Connettori per collegamento moduli uscite digitali ME-XXXX-DD *

 Prese SUB-D 37/37 poli
 Collegabili a: Serie H multipolare
 Protezione: IP65

* Vedi pag. 2/3.15.15

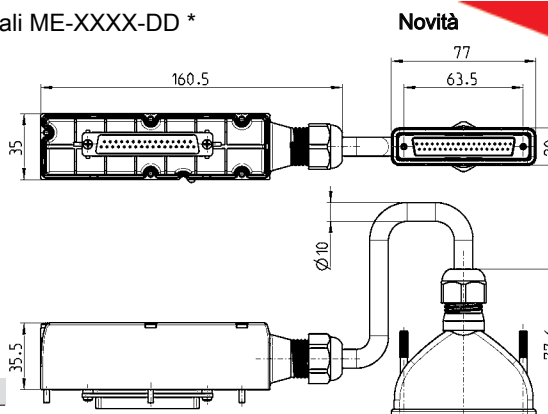

Mod.	N° poli connettore maschio	N° poli connettore femmina	lunghezza cavo (m)
G4X1-H-G9W-3	37	37	3
G4X1-H-G9W-5	37	37	5

Connettore M12 4 poli femmina diritto per alimentazione elettrica

Compatibile con:
serie 3 seriale, serie Y, serie H, serie CX2

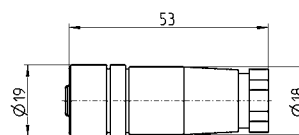

Mod.

CS-LF04HB

Connettore M12 4 poli femmina 90° per alimentazione elettrica

Compatibile con:
serie 3 seriale, serie Y, serie H, serie CX2

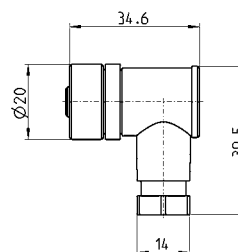

Mod.

CS-LR04HB

Connettori M12/M12B 5 poli femmina dritti per Bus-In

Compatibili con:
serie 3 seriale, serie Y, serie H e serie CX2

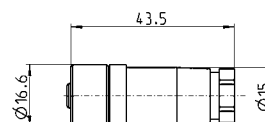

Mod.

CS-MF05HC

Profibus-DP (M12B)

CS-LR05HC

CANopen - DeviceNet (M12)

Connettori M12/M12B 5 poli femmina angolari (90°) per Bus-In

Compatibili con:
serie 3 seriale, serie Y, serie H e serie CX2

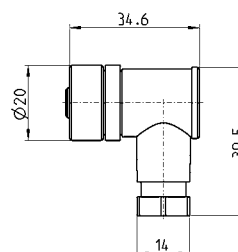

Mod.

CS-MR05HC

Profibus-DP (M12B)

CS-LR05HC

CANopen - DeviceNet (M12)

Connettori M12/M12B 5 poli maschio diritti per Bus-Out

Compatibili con:
serie 3 seriale, serie H e serie CX2

Il Mod. CS-LM05HC può essere utilizzato anche per il collegamento delle uscite del modulo ME-0004-DL (vedi pag. 2/3.20.04).

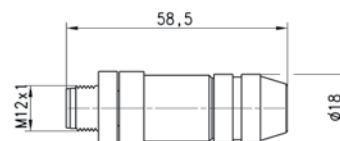

Mod.	
CS-MM05HC	Profibus-DP (M12B)
CS-LM05HC	CANopen - DeviceNet (M12)

Connettori M12/M12B 5 poli maschio angolari (90°) per Bus-Out

Compatibili con:
serie 3 seriale, serie H e serie CX2

Il Mod. CS-LS05HC può essere utilizzato anche per il collegamento delle uscite del modulo ME-0004-DL (vedi pag. 2/3.20.04).

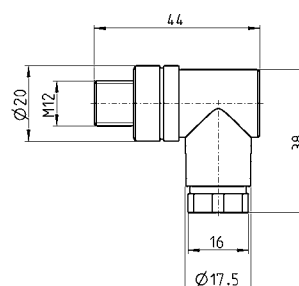

Mod.	
CS-MS05HC	Profibus-DP (M12B)
CS-LS05HC	CANopen - DeviceNet (M12)

Connettori M12/M12B maschio con resistenza di terminazione

Connettori con resistenza di terminazione seriale compatibili con serie 3 seriale, serie H e serie CX2.

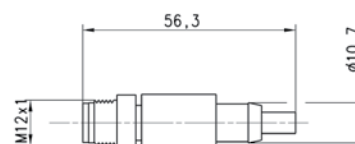

Mod.	
CS-MQ05H0	Profibus-DP (M12B)
CS-LP05H0	CANopen - DeviceNet (M12)

Connettore M9 maschio con resistenza di terminazione Cam.I.Net



Connettore con resistenza di terminazione sottoseriale compatibile con serie Y e H.



Mod.	
CS-FP05H0	

Derivatore a T per Profibus-DP

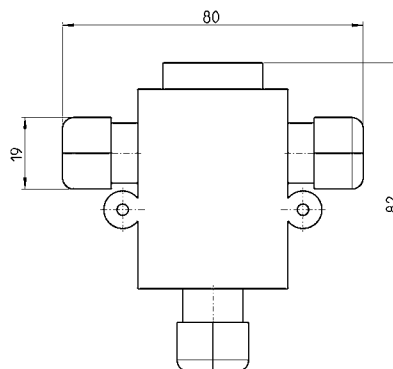
Cavo di collegamento per moduli di Espansione serie Y



Mod.

CS-AA03EC

Derivatore a T per CANopen e DeviceNet

Cavo di collegamento per moduli di Espansione serie Y e H

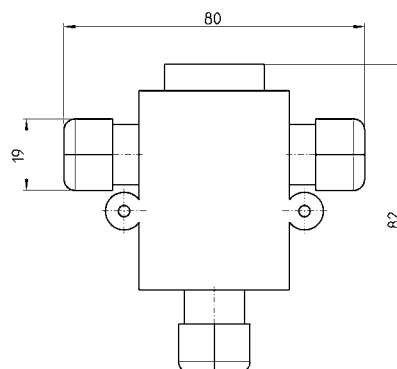

Mod.

CS-AA05EC

Connettore DUO M12 5 poli maschio diritto

Per il collegamento dei moduli ingressi digitali ME-1600-DL (pag. 2/3.10.14) e dei moduli uscite digitali ME-0004-DL (pag. 2/3.20.04).

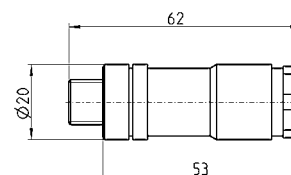

Mod.

CS-LD05HF

Connettore DUO M12 5 poli maschio angolare (90°)

Per il collegamento dei moduli ingressi digitali ME-1600-DL (pag. 2/3.10.14) e e dei moduli uscite digitali ME-0004-DL (pag. 2/3.20.04).

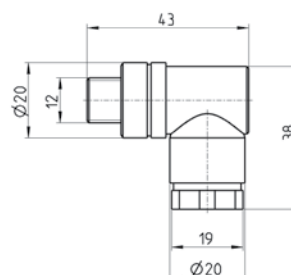

Novità

Mod.

CS-LH05HF

Cavo di programmazione per serie Y

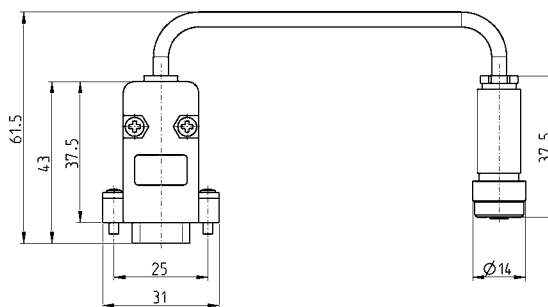
Manuali, configuratore e file di configurazione disponibili sul sito www.camozzi.com nella sezione Area Prodotti/Download.

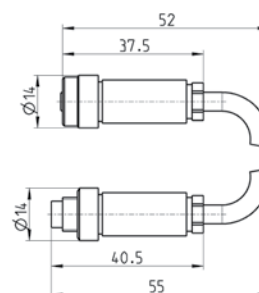

Mod.	lunghezza cavo (m)
CS-FZ03AD-C500	5

Cavo di espansione per serie Y e H

Mod.	lunghezza cavo (m)
CS-FW05HE-D025	0,25
CS-FW05HE-D100	1
CS-FW05HE-D250	2,5
CS-FW05HE-D500	5
CS-FW05HE-DA00	10

Prolunga con connettore M8 3 poli maschio-femmina

Per il collegamento dei moduli ingressi digitali ME-0008-DC (vedi serie 3 seriale, H e CX2).

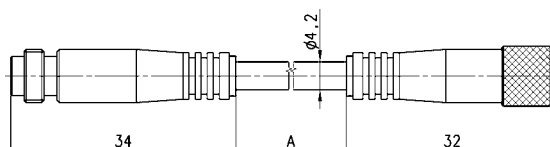

Mod.	lunghezza cavo "A" (m)
CS-DW03HB-C250	2,5
CS-DW03HB-C500	5

Convertitore USB-SERIALE per cavo programmazione
Novità

Per Serie Y

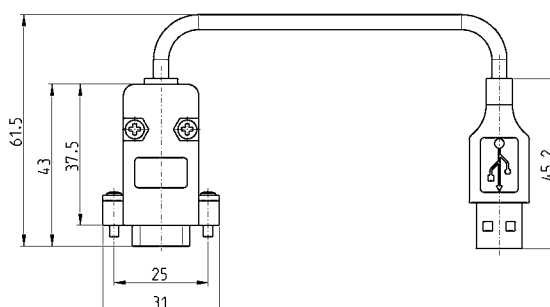

Mod.	lunghezza cavo (m)
G8X3-G8W-1	1

Connettori per collegamento elettrico serie Y versione Punto-Punto

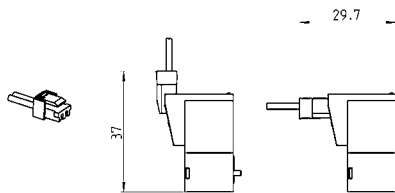

Mod.	lunghezza cavo (mm)
121-803	300
121-806	600
121-810	1000

Tappi per moduli ingressi/uscite digitali serie 3 seriale, H e CX2

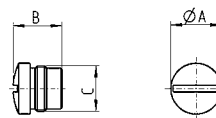

Mod.	A	B	C	Montaggio
CS-DFTP	10	11	M8	ME-0008-DC
CS-LFTP	13,5	13	M12	ME-1600-DL - ME-0004-DL

Elemento di fissaggio per canalina serie 3 seriale, Y, H e CX2



DIN EN 50022 (mm 7,5 x 35 - spessore 1)
Adattabile a tutti i convogliatori

La fornitura comprende:
N°2 piastrine
N°2 viti

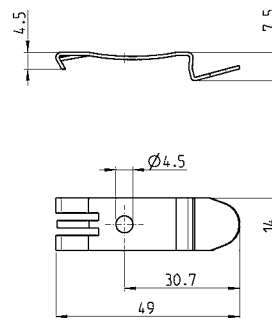

Mod.
PCF-E520