

Raccordi universali Serie 1000

Raccordi ad ogiva per tubi plastici, rame, ottone: \varnothing 4, 6, 8, 10, 12 mm
 Attacchi: G1/8, G1/4, R1/8, R1/4, R3/8, R1/2

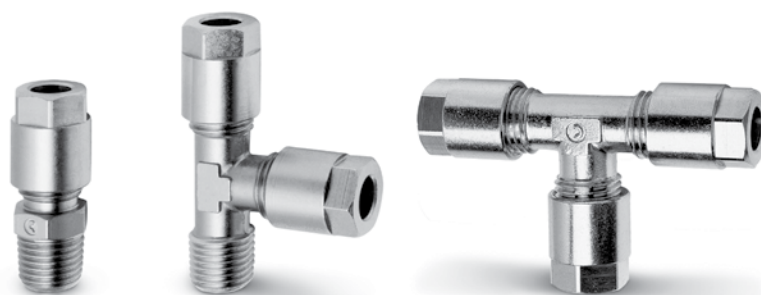

4

COLLEGAMENTO

CARATTERISTICHE GENERALI

Materiale	OT nichelato
Filettature	GAS conico ISO 7 (BSPT) GAS cilindrico ISO 228 (BSP)
Pressione	max pressione 40 bar
Tubo di collegamento	rame ricotto e tubi plastici (con rinforzo)
Diametri	da 4 mm + 12 mm
Fluido	aria compressa e altri fluidi a bassa pressione
Temperatura	(vedere caratteristiche dei tubi impiegati)

Raccordi universali

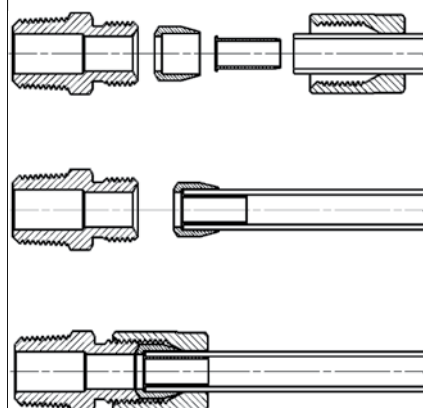

Raccordi Mod. 1050

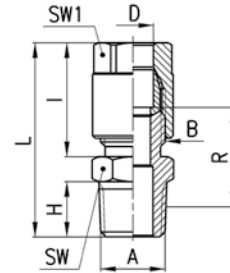

INGOMBRI										
Mod.	D	A	B	H	I	L	R	SW	SW1	Peso (g)
1050 4-1/8	4	R1/8	1/8	7,5	19	31	14	12	12	19
1050 6-1/8	6	R1/8	1/8	7,5	19	31	14	12	12	18
1050 6-1/4	6	R1/4	1/8	11	19	35	16,5	14	12	23
1050 8-1/8	8	R1/8	1/4	7,5	23	35	15,5	14	14	29
1050 8-1/4	8	R1/4	1/4	11	23	39	18	14	14	33
1050 8-3/8	8	R3/8	1/4	11,5	23	39,5	18	17	14	40
1050 10-1/4	10	R1/4	3/8	11	25,5	41,5	18	17	17	51
1050 10-3/8	10	R3/8	3/8	11,5	25,5	42	18	17	17	55
1050 10-1/2	10	R1/2	3/8	14	25,5	45	18	22	17	65
1050 12-1/4	12	R1/4	M18x1,5	11	24,5	40,5	12	19	19	56 *
1050 12-3/8	12	R3/8	M18x1,5	11,5	24,5	41	12	19	19	58 *
1050 12-1/2	12	R1/2	M18x1,5	14	24,5	44	12	22	19	68 *

* = con ogiva biconica

Raccordi Mod. 1063

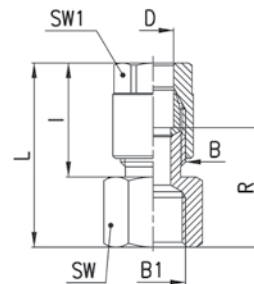

INGOMBRI									
Mod.	D	B1	B	I	L	R	SW	SW1	Peso (g)
1063 4-1/8	4	G1/8	1/8	19	29	18,5	13	12	19
1063 6-1/8	6	G1/8	1/8	19	29	18,5	13	12	18
1063 6-1/4	6	G1/4	1/8	19	30,5	20	17	12	25
1063 8-1/8	8	G1/8	1/4	23	33	20	14	14	31
1063 8-1/4	8	G1/4	1/4	23	34,5	21,5	17	14	35

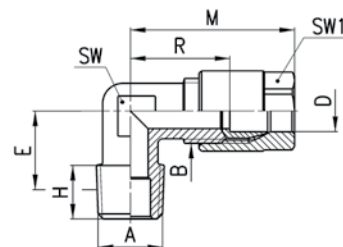
Raccordi Mod. 1020

INGOMBRI										
Mod.	D	A	B	E	H	M	R	SW	SW1	Peso (g)
1020 4-1/8	4	R1/8	1/8	11,5	7,5	29,5	19	9	12	21
1020 6-1/8	6	R1/8	1/8	11,5	7,5	29,5	19	9	12	19
1020 6-1/4	6	R1/4	1/8	13,5	11	29,5	19	12	12	27
1020 8-1/8	8	R1/8	1/4	11,5	7,5	33	20	11	14	35
1020 8-1/4	8	R1/4	1/4	13,5	11	33	20	12	14	36
1020 8-3/8	8	R3/8	1/4	15,5	11,5	35	22	14	14	50
1020 10-1/4	10	R1/4	3/8	15	11	38	22,5	13	17	59
1020 10-3/8	10	R3/8	3/8	15,5	11,5	38	22,5	14	17	58
1020 10-1/2	10	R1/2	3/8	16	14	38	22,5	16	17	78
1020 12-1/4	12	R1/4	M18x1,5	15	11	37	16,5	15	19	66 *
1020 12-3/8	12	R3/8	M18x1,5	15	11,5	37	16,5	15	19	66 *
1020 12-1/2	12	R1/2	M18x1,5	16	14	37	16,5	16	19	75 *

* = con ogiva biconica

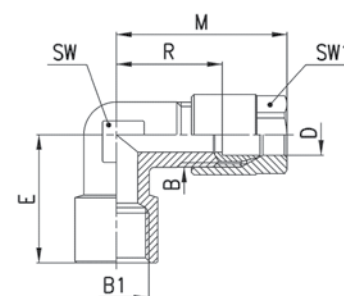
Raccordi Mod. 1093

INGOMBRI									
Mod.	D	B1	B	E	M	R	SW	SW1	Peso (g)
1093 4-1/8	4	G1/8	1/8	19	29,5	18,5	12	12	31
1093 6-1/8	6	G1/8	1/8	19	29,5	19	12	12	25
1093 6-1/4	6	G1/4	1/8	23	30,5	20	13	12	39
1093 8-1/8	8	G1/8	1/4	19	33	20	11	14	39
1093 8-1/4	8	G1/4	1/4	23	35	22	13	14	44

Raccordi Mod. 1000

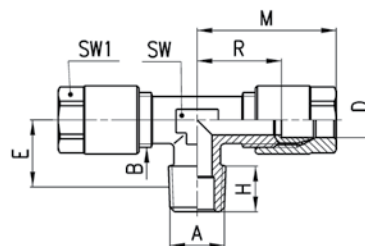

INGOMBRI										
Mod.	D	A	B	E	H	M	R	SW	SW1	Peso (g)
1000 4-1/8	4	R1/8	1/8	11,5	7,5	29,5	19	9	12	35
1000 6-1/8	6	R1/8	1/8	11,5	7,5	29,5	19	9	12	33
1000 8-1/4	8	R1/4	1/4	13,5	11	33	20	12	14	63
1000 10-1/4	10	R1/4	3/8	15	11	38	22,5	13	17	104

Raccordi Mod. 1010

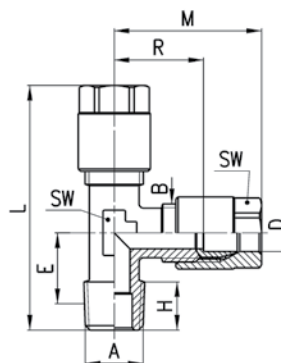

INGOMBRI											
Mod.	D	A	B	E	H	L	M	R	SW	SW1	Peso (g)
1010 4-1/8	4	R1/8	1/8	11,5	7,5	48	29,5	19	9	12	37
1010 6-1/8	6	R1/8	1/8	11,5	7,5	48	29,5	19	9	12	33
1010 8-1/4	8	R1/4	1/4	13,5	11	54,5	33	20	12	14	61
1010 10-1/4	10	R1/4	3/8	15	11	61,5	38	22,5	13	17	103

Raccordi Mod. 1230

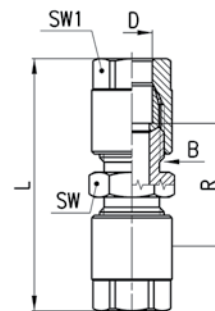

INGOMBRI							
Mod.	D	B	L	R	SW	SW1	Peso (g)
1230 4	4	1/8	42,5	21,5	12	12	29
1230 6	6	1/8	42,5	21,5	12	12	26
1230 8	8	1/4	51	25	14	14	48
1230 10	10	3/8	56	25	17	17	83
1230 12	12	M18x1,5	54	13	19	19	140 *

* = con ogiva biconica

Raccordi Mod. 1250

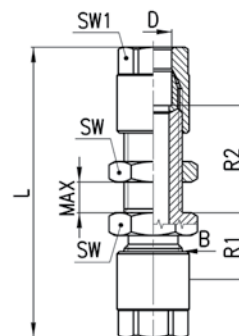

INGOMBRI									
Mod.	D	B	L	R1	R2	MAX	SW	SW1	Peso (g)
1250 4	4	1/8	57,5	12,5	23	12	14	12	40
1250 6	6	1/8	57,5	13	23,5	12	14	12	38
1250 8	8	1/4	65	15	24	13	17	14	67
1250 10	10	3/8	72,5	15	26,5	13	22	17	119

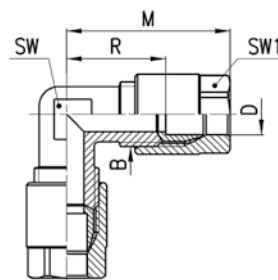
Raccordi Mod. 1220

INGOMBRI

Mod.	D	B	M	R	SW	SW1	Peso (g)
1220 4	4	1/8	29,5	19	9	12	31
1220 6	6	1/8	29,5	19	9	12	29
1220 8	8	1/4	33	20	11	14	53
1220 10	10	3/8	38	22,5	14	17	92
1220 12	12	M18x1,5	37	16,5	16	19	99 *

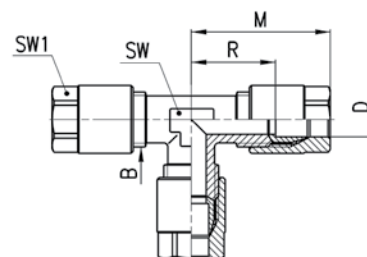
* = con ogiva biconica

Raccordi Mod. 1210

INGOMBRI

Mod.	D	B	M	R	SW	SW1	Peso (g)
1210 4	4	1/8	29,5	19	9	12	45
1210 6	6	1/8	29,5	19	9	12	42
1210 8	8	1/4	33	20	12	14	79
1210 10	10	3/8	38	22,5	13	17	133
1210 12	12	M18x1,5	37	16,5	16	19	144 *

* = con ogiva biconica

Raccordi Mod. 1170

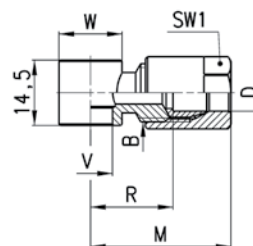
Assemblabili con Mod. 1631

INGOMBRI

Mod.	D	B	R	M	V	W	SW1	Peso (g)
1170 6-1/8	6	1/8	17,5	28	9,8	∅ 14	12	20
1170 6-1/4	6	1/8	20	30,5	13,2	∅ 18	12	24
1170 8-1/8	8	1/4	18	31	9,8	∅ 14	14	31 *

* = assemblabile con Mod. 1635

Dado di bloccaggio Mod. 1303

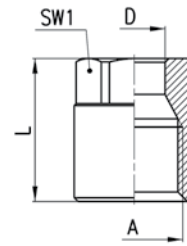

INGOMBRI					
Mod.	D	A	L	SW1	Peso (g)
1303 4-1/8	4	1/8	15,5	12	8
1303 6-1/8	6	1/8	15,5	12	8
1303 8-1/4	8	1/4	19	14	14
1303 10-3/8	10	3/8	21,5	17	24
1303 12-M18x1,5	12	M18x1,5	19,5	19	27

Ogive Mod. 1310

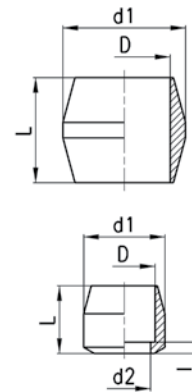

INGOMBRI						
Mod.	D	d1	d2	l	L	Peso (g)
1310 4	4	7,8	3	1	8	2
1310 6	6	7,8	4,5	1	7	1
1310 8	8	10,8	7	1,5	9	3
1310 10	10	13,8	9	1,5	11,5	5
1310 12-M18	12	16,3	12	-	11	6 *

* = biconica

Inserti Mod. 1320

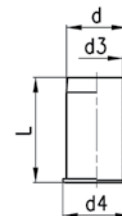

INGOMBRI					
Mod.	d	d3	d4	L	Peso (g)
1320 4	4	3	5	12	1
1320 6	6	5	7	13	1
1320 8	8	7	9	14	1
1320 10	10	9	11	16	2